



befame

Bellissa

Bellissa is the undisputed queen of the interior, perfect for those who are not afraid of bold design and distinctive details. Does that match you? Look at these characteristic creases - they give a glamorous look in combination with velour material and decorated, high legs. Soft, spacious seat cushions filled with a special silicone compound and loose back cushions are a promise of rest and relaxation. This sofa consists of two separate modules, which make it very easy to transport, and with a little creativity, this may come in handy in your interior design. It is, in a word, so unique that cannot be left unnoticed. Going to take it home?

Corner sofas

Available in a left-hand or right-hand configuration. The sets below are left-hand facing. _____

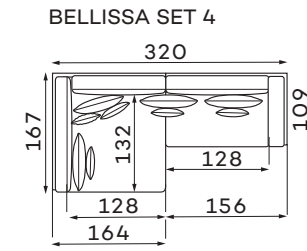
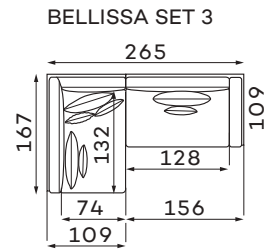
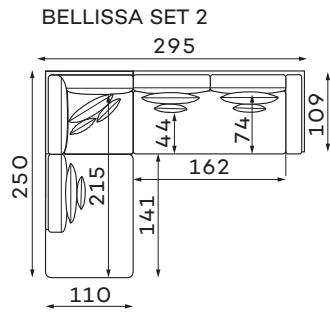
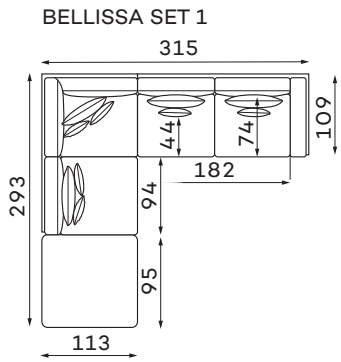

Sofas

2-SEATER SOFA WITHOUT SLEEPING FUNCTION

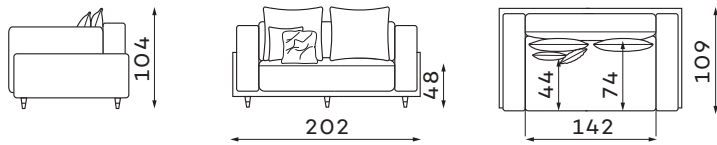

3-SEATER SOFA WITHOUT SLEEPING FUNCTION

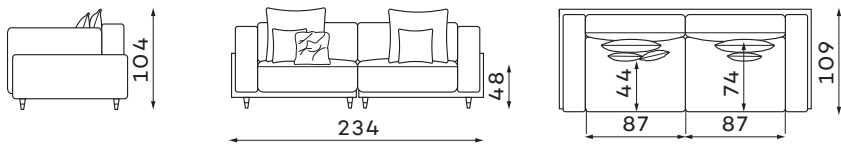

4-SEATER SOFA WITHOUT SLEEPING FUNCTION

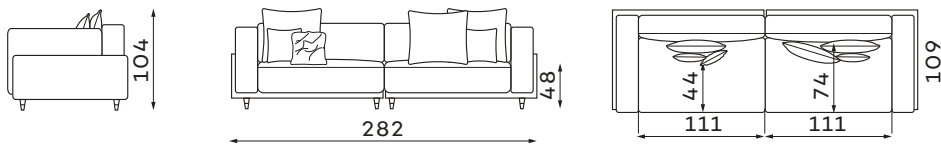

Modular units

Available in a left-hand or right-hand configuration. The sets below are left-hand facing.

CORNER UNIT

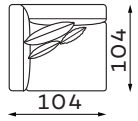

1,5-SEATER UNIT

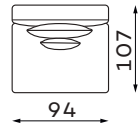

1,5-SEATER ONE ARM UNIT

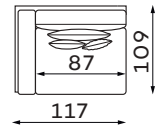

2-SEAT ONE ARM UNIT

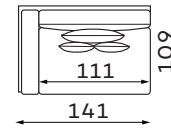

2,5-SEAT ONE ARM UNIT

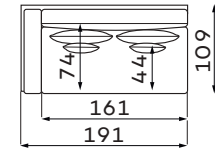

CHAISE UNIT M

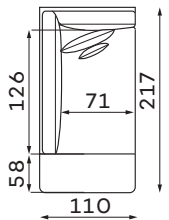

CHAISE UNIT L

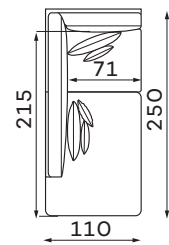

SMALL POUFFE

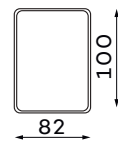

LARGE POUFFE

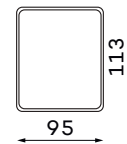

Pouffe height: 48

All dimensions of upholstered furniture are given with a tolerance of +/- 4 cm.

Other dimensions

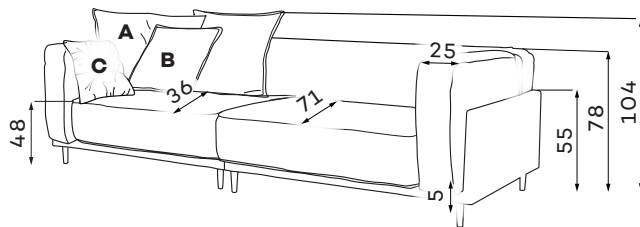

CUSHION A

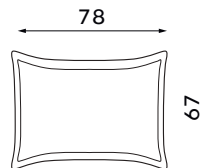

CUSHION B

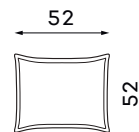

CUSHION C

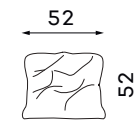

Leg colors available

BLACK
-BRASS



BLACK



What makes the Bellissa sofa stand out?



They make the seat more flexible and provide excellent underlying support for a highly flexible foam layer.



You can choose the fabric from dedicated series, including easy-to-clean fabrics.



The upholstered back allows you to put it in the middle of the living room.



The highly-flexible foam improves the durability and elasticity of the seat, preventing deformations.



The ergonomic and comfortable design of the backrest and seat perfectly fits the curve of the human body.



The series comes with several colours of legs. Choose your own colour. Do you want to buy the same legs for a chest of drawers? Of course, you can!

V 02. Product images are for illustrative purposes only and may differ from the actual product. Dimensions in technical descriptions are approximate and may vary (with a tolerance of +/- 3% -4%). The company reserves the right to change the technical specifications provided in product datasheets for regular updates without prior notice.